





HUS Screw anchor, carbon steel

	Anchor version	Benefits
	HUS-A 6 Carbon steel Concrete Screw with hex head	<ul style="list-style-type: none"> - Quick and easy setting - Low expansion forces in base materials - Through fastening - Removable - Forged-on washer and hexagon head with no protruding thread
	HUS-H 6 Carbon steel Concrete Screw with hex head	
	HUS-H 8 HUS-H 10 HUS-H 14 Carbon steel Concrete Screw with hex head	
	HUS-I 6 Carbon steel Concrete Screw with hex head	
	HUS-P 6 Carbon steel Concrete Screw with pan head	



Concrete



Tensile zone

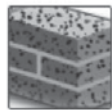

Solid brick

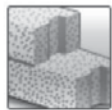

Autoclaved aerated concrete



Small edge distance and spacing



Fire resistance



European Technical Approval



CE conformity



PROFIS Anchor design software

Approvals / certificates

Description	Authority / Laboratory	No. / date of issue
European technical approval ^{a)} with fire assessment according TR020	DIBt, Berlin	ETA-08/0307/ 2014-04-29
Fire test report	IBMB, Brunswick	UB3574/5146/ 2006-05-20
Fire Assessment report	Exova Warringtonfire	WF 166402/ 2007-10-26

a) Does not include HUS-H 14

Basic loading data for concrete C20/25

All data in this section applies to

- Correct setting (see setting instruction)
- No edge distance and spacing influence
- *Steel* failure
- Minimum base material thickness
- Concrete C 20/25, $f_{ck,cube} = 25 \text{ N/mm}^2$

For details see simplified design method

The following technical data are based on:

ETA: Data according ETA-08/0307 issue 2014-04-29

Hilti: Additional Hilti technical data

Mean ultimate resistance

		ETA-08/0307						Hilti				
Anchor size		6		8		10		8	10	14		
Type	HUS-	A, H, I	P	H		H		H	H	H		
h_{nom}	[mm]	55	55	60	75	70	85	50	60	70	90	110
Non-cracked concrete												
Tensile $N_{Ru,m}$	[kN]	12,0	10,0	16,0	21,3	16,0	26,7	11,2	16,0	23,8	36,9	56,0
Shear $V_{Ru,m}$	[kN]	13,2	13,2	16,7	16,7	25,1	25,1	16,7	25,1	47,6	53,8	53,8
Cracked concrete												
Tensile $N_{Ru,m}$	[kN]	8,0		8,0	12,0	10,0	21,3	5,2	8,5	-	19,1	-
Shear $V_{Ru,m}$	[kN]	13,2		16,7	16,7	25,1	25,1	16,7	25,1	-	53,8	-

Characteristic resistance

		ETA-08/0307						Hilti				
Anchor size		6		8		10		8	10	14		
Type	HUS-	A, H, I	P	H		H		H	H	H		
h_{nom}	[mm]	55	55	60	75	70	85	50	60	70	90	110
Non-cracked concrete												
Tensile N_{Rk}	[kN]	9,0	7,5	12,0	16,0	12,0	20,0	8,4	12,0	17,8	27,6	42
Shear V_{Rk}	[kN]	12,5	12,5	15,9	15,9	23,8	23,8	15,9	23,8	35,6	51,2	51,2
Cracked concrete												
Tensile N_{Rk}	[kN]	6,0		6,0	9,0	7,5	16,0	3,9	6,4	-	14,3	-
Shear V_{Rk}	[kN]	12,5		15,9	15,9	23,8	23,8	15,6	21,0	-	39,5	-

Design resistance

		ETA-08/0307						Hilti				
Anchor size		6		8		10		8	10	14		
Type	HUS-	A, H, I	P	H		H		H	H	H		
h_{nom}	[mm]	55	55	60	75	70	85	50	60	70	90	110
Non-cracked concrete												
Tensile N_{Rd}	[kN]	5,0	4,2	6,7	8,9	6,7	9,5	4,7	6,7	9,9	15,4	24,0
Shear V_{Rd}	[kN]	8,3	8,3	10,6	10,6	15,9	15,9	10,6	15,9	23,8	34,1	34,1
Cracked concrete												
Tensile N_{Rd}	[kN]	3,3		3,3	5,0	4,2	7,6	2,2	3,6	-	9,5	-
Shear V_{Rd}	[kN]	8,3		10,6	10,6	15,9	15,9	10,4	14,0	-	26,3	-

Recommended loads

		ETA-08/0307						Hilti				
Anchor size		6		8		10		8	10	14		
Type	HUS-	A, H, I	P	H		H		H	H	H		
h_{nom}	[mm]	55	55	60	75	70	85	50	60	70	90	110
Non-cracked concrete												
Tensile N_{rec}	[kN]	3,6	3,0	4,8	6,3	4,8	6,8	3,3	4,8	7,1	11,0	17,1
Shear V_{rec}	[kN]	6,0	6,0	7,6	7,6	11,3	11,3	7,6	11,3	17,0	24,4	24,4
Cracked concrete												
Tensile N_{rec}	[kN]	2,4		2,4	3,6	3,0	5,4	1,5	2,5	-	6,8	-
Shear V_{rec}	[kN]	6,0		7,6	7,6	11,3	11,3	7,4	10,0	-	18,8	-

a) With overall partial safety factor for action $\gamma = 1,4$. The partial safety factors for action depend on the type of loading and shall be taken from national regulations.

Basic loading data for concrete < 28 days old and $f_{ck,cube} \geq 15 \text{ N/mm}^2$:

All data in this section applies to the following conditions:

Concrete:

- Strength class C 20/25, $f_{ck,cube} \geq 15 \text{ N/mm}^2$

Installation:

- For hand installation $T_{inst,rec} = 40 \text{ Nm}$

The anchor is correct mounted, if there is neither a turn-through or spinning of the screw in the drill hole nor that an easy turning of the screw is possible after the installation procedure when the head of the screw has touched the fixture.

Loads:

- No edge distance and spacing influence
- Minimum base material thickness

Recommended loads in non-cracked concrete

		Hilti		
Anchor size		14	14	14
Type	HUS-	H	H	H
h_{nom}	[mm]	70	90	110
Non-cracked concrete				
Tensile $N_{rec}^{a)}$	[kN]	3,5	5,5	7,5
Shear $V_{rec}^{a)}$	[kN]	6,6	14,0	16,5

a) Values serve as a reference, onsite testing is recommended to determine actual loading potential of the anchors

Basic loading data for single anchor in solid masonry units:

All data in this section applies to the following conditions:

Solid bricks: a reduction of the cross section area by a vertical perforation perpendicular to the bed joint area must not be greater than 15%

Drilling:

- Holes in Mz and KS drilled with TE rotary hammers drilled with hammering mode
- Holes in PPW drilled with TE rotary hammers drilled without hammering mode

Installation:

- The anchor is correct mounted, if there is neither a turn-through or spinning of the screw in the drill hole nor that an easy turning of the screw is possible after the installation procedure when the head of the screw has touched the fixture

Edge distance and spacing influences:

- Distance to free edge free edge to solid masonry (Mz and KS) units $c_{min,free} \geq 200$ mm
- Distance to free edge free edge to solid masonry (autoclaved aerated gas concrete) units $c_{min,free} \geq 170$ mm
- The minimum distance to horizontal and vertical mortar joint $c_{min,h}$ and $c_{min,v}$ is stated in drawing below
- Minimum anchor spacing in one brick/block is $s_{min} = 80$ mm

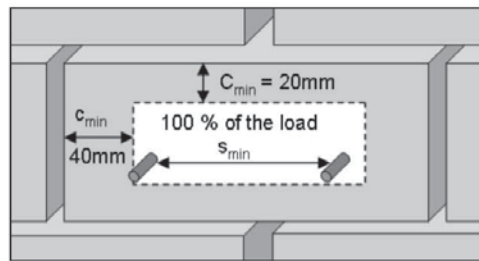

Recommended loads

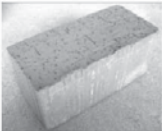
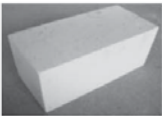
		Hilti		
		6	8	10
Base material	Anchor size			
	Type	A, H, I, P	H	H
	h_{nom} [mm]	55	60	70
Compressive strength class [N/mm ²]		F _{rec} ^{a)} [kN] Tensile and Shear		
 Solid clay brick Mz 2,0-2DF DIN V 105-100 / EN 771-1 LxWxH [mm]: 240x115x113 h _{min} [mm]: 115	≥ 8	0,6	0,8	1,0
	≥ 10	0,7	0,9	1,2
	≥ 12	0,8	1,0	1,3
	≥ 16	0,9	1,2	1,5
	≥ 20	0,9	1,3	1,7
 Solid sand-lime brick KS 2,0-2DF DIN V 106-100 / EN 771-2 LxWxH [mm]: 240x115x113 h _{min} [mm]: 115	≥ 8	0,8	1,0	1,1
	≥ 10	0,9	1,1	1,2
	≥ 12	1,0	1,2	1,3
	≥ 16	1,1	1,3	1,5
	≥ 20	1,2	1,5	1,7

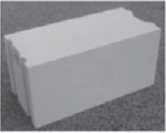
	Aerated concrete PPW -0,65 DIN 4165/ EN 771-4 LxWxH [mm]: 499x240x249 h _{min} [mm]: 240			≥ 6	0,4	0,5	1,3

a) Characteristic resistance for tension, shear or combined tension and shear loading.
 The characteristic resistance is valid for single anchor or for a group of two or four anchors with a spacing equal or larger than the minimum spacing s_{min} according to specification.

Load values:

- The technical data for the HUS-H anchors are reference loads for MZ 12 2,0-2DF, KS 12 2,0-2DF and PPW 6-0,65.
- The load Values are valid for non-structural applications.
- Due to the natural variation of stone solid bricks, on site anchor testing is recommended to validate technical data.
- The HUS-H anchor was installed and tested in the centre area of solid bricks as shown considering minimal edge and space distances.
- The HUS-H anchor was not tested in the mortar joint between solid bricks or in hollow bricks; however a load reduction is expected.
- For brick walls where anchor position in brick can not be determined, 100% anchor testing is recommended.

Limitations of loads:

- All data is for redundant fastening for non structural applications
- Plaster, graveling, lining or leveling courses are regarded as non-bearing and may not be taken into account for the calculation of embedment depth.
- The decisive resistance to tension loads is the lower value of N_{rec} (brick breakout, pull out) and $N_{max,pb}$ (pull out of one brick).

Pull out of one brick:

The allowable load of an anchor or a group of anchors in case of single brick pull out, $N_{max,pb}$ [kN], is given in the following tables:

Clay bricks:

$N_{max,pb}$ [kN]		brick breadth b_{brick} [mm]					
		80	120	200	240	300	360
brick length l_{brick} [mm]	240	1,1	1,6	2,7	3,3	4,1	4,9
	300	1,4	2,1	3,4	4,1	5,1	6,2
	500	2,3	3,4	5,7	6,9	8,6	10,3

All other brick types:

$N_{max,pb}$ [kN]		brick breadth b_{brick} [mm]					
		80	120	200	240	300	360
brick length l_{brick} [mm]	240	0,8	1,2	2,1	2,5	3,1	3,7
	300	1,0	1,5	2,6	3,1	3,9	4,6
	500	1,7	2,6	4,3	5,1	6,4	7,7

$N_{max,pb}$ = resistance for pull out of one brick
 l_{brick} = length of the brick
 b_{brick} = breadth of the brick

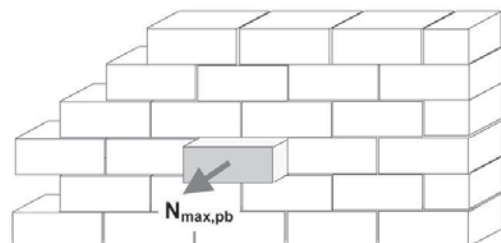

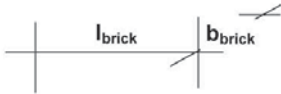

Materials

Mechanical properties

Anchor size		6	8	10	14
Type	HUS-	A, H, I, P	H	H	H
Nominal tensile strength f_{uk}	[N/mm ²]	930	950	1000	770
Yield strength f_{yk}	[N/mm ²]	750	855	900	700
Stressed cross-section A_s	[mm ²]	26,9	39,0	55,4	143,1
Moment of resistance W	[mm ³]	19,6	34,4	58,2	191,7
Design bending resistance $M_{Rd,s}$	[Nm]	21,9	26,1	46,5	118

Material quality

Part	Designation	Material
Screw anchor	HUS-A 6	Carbon Steel, galvanized ($\geq 5 \mu\text{m}$)
	HUS-H 6	
	HUS-I 6	
	HUS-P 6	
	HUS-H 8	
	HUS-H 10	
	HUS-H 14	

Head configuration

HUS-A 6
External thread
M8 or M10

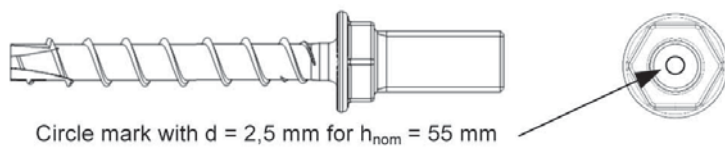

HUS-H 6
Hex head

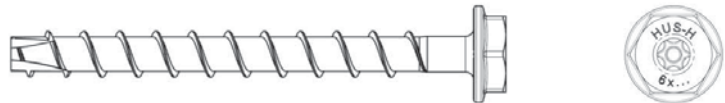

HUS-I 6
Internal threads
M8 and M10

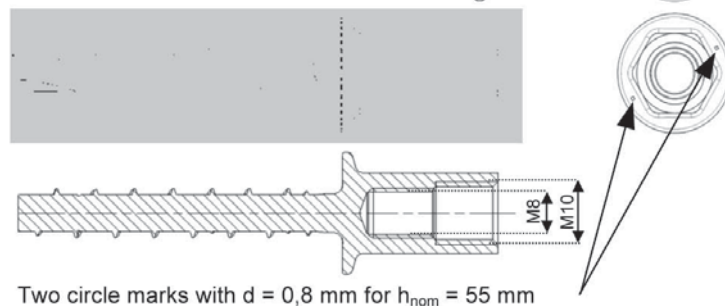

HUS-P 6
Pan head

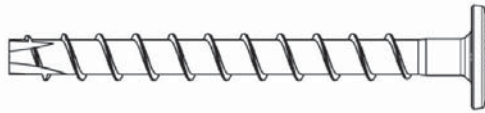

HUS-H 8
HUS-H 10
HUS-H 14

Hex head

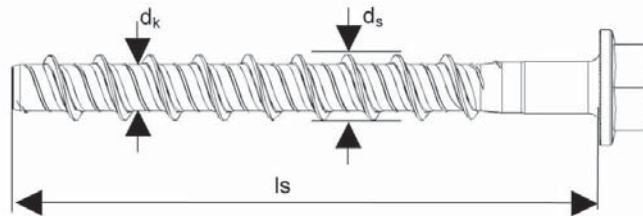

Anchor dimensions:

Dimensions

Anchor size		6				8	10	14
Type	HUS-	A	H	I	P	H	H	H
Nominal length	l_s [mm]	55	60..12 0	55	60..80	65..150	75..280	80..160
Outer diameter of thread	d_s [mm]	7,85				10,1	12,3	16,55
Core diameter	d_k [mm]	5,85				7,1	8,4	12,6

Setting:

Recommended installation equipment

Anchor Size	6				8			10			14			
Type	HUS-	A	I	H	P	H			H					
h_{nom}	[mm]	55				50	60	70	60	70	85	70	90	110
Rotary hammer		TE 2 - TE 7				TE 2 - TE 30								
drill bit for concrete, solid clay brick solid sand-lime brick		TE -CX 6				TE -CX 8			TE -CX 10			TE -CX 14		
drill bit for aerated concrete		TE -CX 5				TE -CX 6			TE -CX 8			-		
Socket wrench insert		S-NSD 13 1/2 L		-		S-NSD 13 1/2 L			S-NSD 15 1/2			S-NSD 21 1/2		
TORX		-		TXI 30		-			-			-		
Setting tool		SIW/ SID 121 SIW/ SID 144 TKI 2500				SIW 22T-A SI 100								

Setting details for concrete from C20/25 to C50/60

Anchor size			6				8			10			14		
Type	HUS-		A	I	H	P	H			H			H		
h_{nom}	[mm]		55				50	60	70	60	70	85	70	90	110
Nominal diameter of drill bit	d_0	[mm]	6				8			10			14		
Cutting diameter of drill bit	$d_{cut} \leq$	[mm]	6,4				8,45			10,45			14,50		
Clearance hole diameter	d_f	[mm]	9				12			14			18		
Depth of drill hole in floor/ wall position	$h_1 \geq$	[mm]	$h_{nom}+10$ mm				$h_{nom}+10$ mm			$h_{nom}+10$ mm			$h_{nom}+10$ mm		
Depth of drill hole in ceiling position	$h_1 \geq$	[mm]	$h_{nom}+3$ mm												
Thickness of fixture	t_{fix}	[mm]	$l_s - h_{nom}$												
Max. installation torque for hand setting	max. T_{inst}	[Nm]	25				35	35	45	45	45	55	65 (40) ^{a)}		
Impact screw driver for machine setting			SIW/SID 121,144 TKI 2500				SIW 22T-A SI 100					SIW 22T-A SI 100 ^{b)}			

^{a)} For concrete < 28 days old and $f_{ck,cube} \geq 15$ N/mm²

^{b)} For concrete < 28 days old and $f_{ck,cube} \geq 15$ N/mm² only hand setting is recommended

Setting details for masonry

Anchor size			6				8			10		
Type	HUS-		A	I	H	P	H			H		
h_{nom}	[mm]		55				60			70		
Nominal diameter of drill bit diameter for solid clay (Mz) and sand-lime brick (KS)	d_0	[mm]	6				8			10		
Nominal diameter of drill bit Aerated concrete (PPW)	d_0	[mm]	5				6			8		
Clearance hole diameter	d_f	[mm]	9				12			14		
Depth of drill hole	$h_1 \geq$	[mm]	$h_{nom}+10$ mm									
Thickness of fixture	t_{fix}	[mm]	$l_s - h_{nom}$									
Max. installation torque for hand setting ^{a)}												
Solid clay brick (MZ)	max. T_{inst}	[Nm]	8				8			8		
Solid sand-lime brick (KS)	max. T_{inst}	[Nm]	12				16			16		
Aerated concrete (PPW)	max. T_{inst}	[Nm]	5				5			8		

^{a)} Only hand setting is recommended

Setting instruction

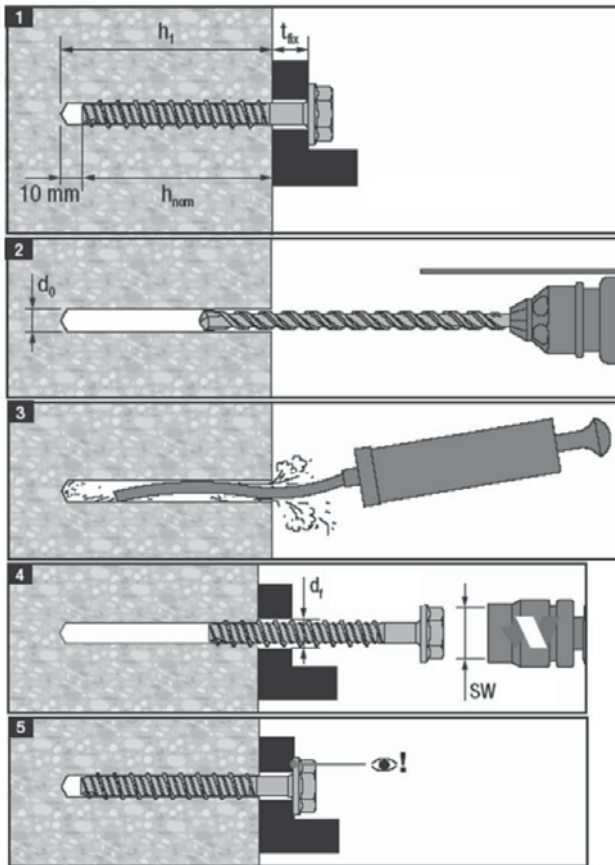

For detailed information on installation see instruction for use given with the package of the product.

Base material thickness, anchor spacing and edge distance for concrete from C20/25 to C50/60

Anchor size			6		8			10			14	
Type	HUS-	A, I, H, P	H			H			H			
h_{nom}	[mm]	55	50	60	75	60	70	85	70	90	110	
Minimum base material thickness	h_{min}	[mm]	100	100	110	120	110	130	130	130	170	210
non-cracked concrete	Minimum spacing	s_{min}	35			55			65			80
	Minimum edge distance	c_{min}	35			55			65			60
cracked concrete	Minimum spacing	s_{min}	35	55	40	40	65	50	50	-	80	-
	Minimum edge distance	c_{min}	35	55	50	50	65	50	50	-	60	-
Effective anchorage depth	h_{ef}	[mm]	42	36	47	60	44	54	67	50	69	90
Critical spacing for concrete cone failure	$s_{cr,N}$	[mm]	$3 h_{ef}$									
Critical spacing for splitting failure	$s_{cr,sp}$	[mm]										
Critical edge distance for concrete cone failure	$c_{cr,N}$	[mm]	$1,5 h_{ef}$									
Critical edge distance for splitting failure	$c_{cr,sp}$	[mm]										

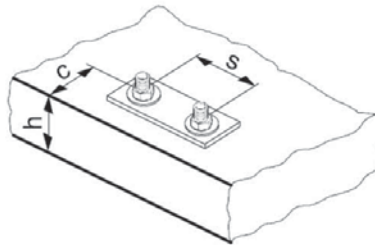

For spacing and/ or edge distance smaller than critical spacing and/ or critical edge distance the design loads have to be reduced.

Critical spacing and critical edge distance for splitting failure apply only for non-cracked concrete. For cracked concrete only the critical spacing and critical edge distance for concrete cone failure are decisive.

Simplified design method

Simplified version of the design method according ETAG 001, Annex C. Design resistance according data given in ETA-08/0307 issue 2014-04-29.

- Influence of concrete strength
- Influence of edge distance
- Influence of spacing

- Valid for a group of two anchors. (The method may also be applied for anchor groups with more than two anchors or more than one edge. The influencing factors must then be considered for each edge distance and spacing. The calculated design loads are then on the same side: They will be lower than the exact values according ETAG 001, Annex C. To avoid this, it is recommended to use the anchor design software PROFIS anchor)

The design method is based on the following simplification:

- No different loads are acting on individual anchors (no eccentricity)

The values are valid for one anchor.

For more complex fastening applications please use the anchor design software PROFIS Anchor.

Tension loading

The design tensile resistance is the lower value of

- Steel resistance: $N_{Rd,s}$
- Concrete pull-out resistance: $N_{Rd,p} = N_{Rd,p}^0 \cdot f_B$
- Concrete cone resistance: $N_{Rd,c} = N_{Rd,c}^0 \cdot f_B \cdot f_{1,N} \cdot f_{2,N} \cdot f_{3,N} \cdot f_{re,N}$
- Concrete splitting resistance (only non-cracked concrete):
For HUS-A, H, I, P $N_{Rd,sp} = N_{Rd,sp}^0 \cdot f_B \cdot f_{1,sp} \cdot f_{2,sp} \cdot f_{3,sp} \cdot f_{h,sp} \cdot f_{re,N}$
For all the other HUS $N_{Rd,sp} = N_{Rd,c}^0 \cdot f_B \cdot f_{1,sp} \cdot f_{2,sp} \cdot f_{3,sp} \cdot f_{h,sp} \cdot f_{re,N}$

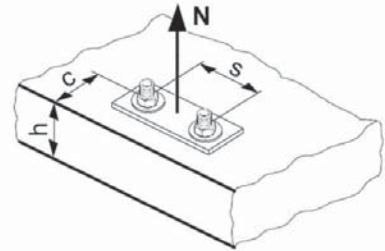

Basic design tensile resistance

Design steel resistance $N_{Rd,s}$

Anchor size	ETA-08/0307			Hilti
	HUS-A, H, I, P	HUS-H 8	HUS-H 10	HUS-H 14
$N_{Rd,s}$ [kN]	16,7	26,5	39,6	67,5

ETA: Data according ETA-08/0307 issue 2014-04-29 Hilti: Additional Hilti technical data

Design pull-out resistance $N_{Rd,p} = N_{Rd,p}^0 \cdot f_B$

Anchor size	ETA-08/0307						Hilti				
	6		8		10		8	10	14		
Type	HUS-A, H, I		P		H		H				
h_{nom}	55	55	60	75	70	85	50	60	70	90	110
Non-cracked concrete											
Tensile $N_{Rd,p}^0$ [kN]	5	4,2	6,7	8,9	6,7	9,5	4,7	6,7	14,7	22,7	28,0
Cracked concrete											
Tensile $N_{Rd,p}^0$ [kN]	3,3	3,3	3,3	5,0	4,2	7,6	2,2	3,6	-	9,5	-

ETA: Data according ETA-08/0307 issue 2014-04-29 Hilti: Additional Hilti technical data

Design concrete cone resistance $N_{Rd,c} = N_{Rd,c}^0 \cdot f_B \cdot f_{1,N} \cdot f_{2,N} \cdot f_{3,N} \cdot f_{re,N}$

Design splitting resistance $N_{Rd,sp} = N_{Rd,sp}^0 \cdot f_B \cdot f_{1,sp} \cdot f_{2,sp} \cdot f_{3,sp} \cdot f_{h,sp} \cdot f_{re,N}$

b) $N_{Rd,sp} = N_{Rd,p}^0 \cdot f_B \cdot f_{1,sp} \cdot f_{2,sp} \cdot f_{3,sp} \cdot f_{h,sp} \cdot f_{re,N}$

Anchor size	ETA-08/0307					Hilti				
	6	8	8	10	10	8	10	14	14	14
h_{nom}	55	60	75	70	85	50	60	70	90	110
Non-cracked concrete										
Tensile $N_{Rd,c}^0$ [kN]	7,6	9,0	13,0	11,1	13,2	6,0	8,2	11,9	18,4	28,7
Cracked concrete										
Tensile $N_{Rd,c}^0$ [kN]	5,4	6,4	9,3	7,9	9,4	4,3	5,8	-	13,2	-

a) Splitting resistance must only be considered for non-cracked concrete

b) Equation valid for HUS-A, H, I, P 6

ETA: Data according ETA-08/0307 issue 2014-04-29 Hilti: Additional Hilti technical data

Influencing factors

Influence of concrete strength

Concrete strength designation (ENV 206)	HUS	h_{nom}	C 20/2 5	C 25/3 0	C 30/3 7	C 35/4 5	C 40/5 0	C 45/5 5	C 50/6 0
$f_B = (f_{ck,cube}/25N/mm^2)^{0,5}$ a)	6	55	1	1,10	1,22	1,34	1,41	1,48	1,55
	8	50...75							
	10	85							
	14	70...1 10							
$f_B = (f_{ck,cube}/25N/mm^2)^{0,4}$ a)	10	60...70	1	1,08	1,17	1,27	1,32	1,37	1,42

a) $f_{ck,cube}$ = concrete compressive strength, measured on cubes with 150 mm side length

Influence of edge distance a)

$c/c_{cr,N}$	0,1	0,2	0,3	0,4	0,5	0,6	0,7	0,8	0,9	1
$c/c_{cr,sp}$										
$f_{1,N} = 0,7 + 0,3 \cdot c/c_{cr,N} \leq 1$	0,73	0,76	0,79	0,82	0,85	0,88	0,91	0,94	0,97	1
$f_{1,sp} = 0,7 + 0,3 \cdot c/c_{cr,sp} \leq 1$										
$f_{2,N} = 0,5 \cdot (1 + c/c_{cr,N}) \leq 1$	0,55	0,60	0,65	0,70	0,75	0,80	0,85	0,90	0,95	1
$f_{2,sp} = 0,5 \cdot (1 + c/c_{cr,sp}) \leq 1$										

a) The edge distance shall not be smaller than the minimum edge distance c_{min} given in the table with the setting details. These influencing factors must be considered for every edge distance.

Influence of anchor spacing a)

$s/s_{cr,N}$	0,1	0,2	0,3	0,4	0,5	0,6	0,7	0,8	0,9	1
$s/s_{cr,sp}$										
$f_{3,N} = 0,5 \cdot (1 + s/s_{cr,N}) \leq 1$	0,55	0,60	0,65	0,70	0,75	0,80	0,85	0,90	0,95	1
$f_{3,sp} = 0,5 \cdot (1 + s/s_{cr,sp}) \leq 1$										

a) The anchor spacing shall not be smaller than the minimum anchor spacing s_{min} given in the table with the setting details. This influencing factor must be considered for every anchor spacing.

Influence of base material thickness

h/h_{ef}	2,0	2,2	2,4	2,6	2,8	3,0	3,2	3,4	3,6	$\geq 3,68$
$f_{h,sp} = [h/(2 \cdot h_{ef})]^{2/3}$	1	1,07	1,13	1,19	1,25	1,31	1,37	1,42	1,48	1,5

Influence of reinforcement

Anchor size	6	8				10			14		
Type	HUS-	A, H, I, P				H			H		
h_{nom}	[mm]	55	50	60	75	60	70	85	70	90	110
h_{ef}	[mm]	42	36	46,9	59,6	44	52,7	66,8	50	67	90
$f_{re,N}^a) = 0,5 + h_{ef}/200mm \leq 1$		0,71	0,68	0,73	0,8	0,72	0,76	0,83	0,7	0,84	0,95

a) This factor applies only for dense reinforcement. If in the area of anchorage there is reinforcement with a spacing ≥ 150 mm (any diameter) or with a diameter ≤ 10 mm and a spacing ≥ 100 mm, then a factor $f_{re,N} = 1$ may be applied.

Shear loading

The design shear resistance is the lower value of

- Steel resistance: $V_{Rd,s}$
- Concrete pryout resistance: $V_{Rd,cp} = V_{Rd,cp}^0 \cdot f_B \cdot f_{1,N} \cdot f_{2,N} \cdot f_{3,N} \cdot f_{re,N}$
- Concrete edge resistance: $V_{Rd,c} = V_{Rd,c}^0 \cdot f_B \cdot f_{\beta} \cdot f_h \cdot f_4$

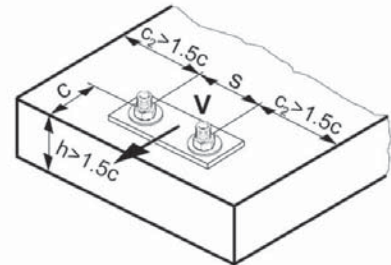

Basic design shear resistance

Design steel resistance $V_{Rd,s}$

		ETA-08/0307			Hilti
Anchor size		HUS-A, H, I, P 6	HUS-H 8	HUS-H 10	HUS-H 14
$V_{Rd,s}$	[kN]	8,3	10,6	15,9	34,1

Design concrete pryout resistance $V_{Rd,cp} = V_{Rd,cp}^0 \cdot f_B \cdot f_{1,N} \cdot f_{2,N} \cdot f_{3,N} \cdot f_{re,N}$

		ETA-08/0307					Hilti				
Anchor size		6	8	8	10	10	8	10	14	14	14
h_{nom}		55	60	75	70	85	50	60	70	90	110
Non-cracked concrete											
$V_{Rd,cp}^0$	[kN]	13,7	21,7	31,2	26,7	36,9	14,5	19,6	23,8	36,9	57,4
Cracked concrete											
$V_{Rd,cp}^0$	[kN]	9,8	15,5	22,3	19,0	26,3	10,4	14,0	-	26,3	-

Design concrete edge resistance $V_{Rd,c} = V_{Rd,c}^0 \cdot f_B \cdot f_{\beta} \cdot f_4$

		ETA-08/0307					Hilti				
Anchor size		6	8	8	10	10	8	10	14	14	14
h_{nom}		55	60	75	70	85	50	60	70	90	110
Non-cracked concrete											
$V_{Rd,c}^0$	[kN]	2,1	2,7	4,1	3,7	5,3	1,7	2,6	3,6	5,9	9,7
Cracked concrete											
$V_{Rd,c}^0$	[kN]	1,5	1,9	3,0	2,6	3,8	1,2	1,9	-	4,2	-

Influencing factors

Influence of concrete strength

Concrete strength designation (ENV 206)	HUS	h_{nom}	C 20/25	C 25/30	C 30/37	C 35/45	C 40/50	C 45/55	C 50/60
$f_B = (f_{ck,cube}/25N/mm^2)^{0,5}$ a)	6	55	1	1,10	1,22	1,34	1,41	1,48	1,55
	8	50...75							
	10	85							
	14	70...110							
$f_B = (f_{ck,cube}/25N/mm^2)^{0,4}$ a)	10	60...70	1	1,08	1,17	1,27	1,32	1,37	1,42

a) $f_{ck,cube}$ = concrete compressive strength, measured on cubes with 150 mm side length

Influence of edge distance a)

$c/c_{cr,N}$	0,1	0,2	0,3	0,4	0,5	0,6	0,7	0,8	0,9	1
$f_{1,N} = 0,7 + 0,3 \cdot c/c_{cr,N} \leq 1$	0,73	0,76	0,79	0,82	0,85	0,88	0,91	0,94	0,97	1
$f_{2,N} = 0,5 \cdot (1 + c/c_{cr,N}) \leq 1$	0,55	0,60	0,65	0,70	0,75	0,80	0,85	0,90	0,95	1

a) The edge distance shall not be smaller than the minimum edge distance c_{min} given in the table with the setting details. These influencing factors must be considered for every edge distance.

Influence of anchor spacing a)

$s/s_{cr,N}$	0,1	0,2	0,3	0,4	0,5	0,6	0,7	0,8	0,9	1
$f_{3,N} = 0,5 \cdot (1 + s/s_{cr,N}) \leq 1$	0,55	0,60	0,65	0,70	0,75	0,80	0,85	0,90	0,95	1

a) The anchor spacing shall not be smaller than the minimum anchor spacing s_{min} given in the table with the setting details. This influence factor must be considered for every anchor spacing.

Influence of reinforcement

Anchor size		6			8			10			14		
Type	HUS-	A, H, I, P			H			H			H		
h_{nom}	[mm]	55			50	60	75	60	70	85	70	90	110
h_{ef}	[mm]	42			36	46,9	59,6	44	52,7	66,8	50	67	90
$f_{re,N} = 0,5 + h_{ef}/200mm \leq 1$		0,71			0,68	0,73	0,8	0,72	0,76	0,83	0,7	0,84	0,95

a) This factor applies only for dense reinforcement. If in the area of anchorage there is reinforcement with a spacing ≥ 150 mm (any diameter) or with a diameter ≤ 10 mm and a spacing ≥ 100 mm, then a factor $f_{re,N} = 1$ may be applied.

Influence of angle between load applied and the direction perpendicular to the free edge

Angle β	0° - 55°	60°	65°	70°	75°	80°	85°	90° - 180°
f_β	1,00	1,07	1,14	1,23	1,35	1,50	1,71	2,00

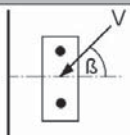

Influence of base material thickness

h/c	0,15	0,3	0,45	0,6	0,75	0,9	1,05	1,2	1,35	$\geq 1,5$
$f_h = \{h/(1,5 \cdot c)\}^{2/3} \leq 1$	0,22	0,34	0,45	0,54	0,63	0,71	0,79	0,86	0,93	1,00

Influence of anchor spacing and edge distance ^{a)} for concrete edge resistance: f_4

$$f_4 = (c/h_{ef})^{1,5} \cdot (1 + s / [3 \cdot c]) \cdot 0,5$$

c/h _{ef}	Single anchor	Group of two anchors s/h _{ef}														
		0,75	1,50	2,25	3,00	3,75	4,50	5,25	6,00	6,75	7,50	8,25	9,00	9,75	10,50	11,25
0,50	0,35	0,27	0,35	0,35	0,35	0,35	0,35	0,35	0,35	0,35	0,35	0,35	0,35	0,35	0,35	0,35
0,75	0,65	0,43	0,54	0,65	0,65	0,65	0,65	0,65	0,65	0,65	0,65	0,65	0,65	0,65	0,65	0,65
1,00	1,00	0,63	0,75	0,88	1,00	1,00	1,00	1,00	1,00	1,00	1,00	1,00	1,00	1,00	1,00	1,00
1,25	1,40	0,84	0,98	1,12	1,26	1,40	1,40	1,40	1,40	1,40	1,40	1,40	1,40	1,40	1,40	1,40
1,50	1,84	1,07	1,22	1,38	1,53	1,68	1,84	1,84	1,84	1,84	1,84	1,84	1,84	1,84	1,84	1,84
1,75	2,32	1,32	1,49	1,65	1,82	1,98	2,15	2,32	2,32	2,32	2,32	2,32	2,32	2,32	2,32	2,32
2,00	2,83	1,59	1,77	1,94	2,12	2,30	2,47	2,65	2,83	2,83	2,83	2,83	2,83	2,83	2,83	2,83
2,25	3,38	1,88	2,06	2,25	2,44	2,63	2,81	3,00	3,19	3,38	3,38	3,38	3,38	3,38	3,38	3,38
2,50	3,95	2,17	2,37	2,57	2,77	2,96	3,16	3,36	3,56	3,76	3,95	3,95	3,95	3,95	3,95	3,95
2,75	4,56	2,49	2,69	2,90	3,11	3,32	3,52	3,73	3,94	4,15	4,35	4,56	4,56	4,56	4,56	4,56
3,00	5,20	2,81	3,03	3,25	3,46	3,68	3,90	4,11	4,33	4,55	4,76	4,98	5,20	5,20	5,20	5,20
3,25	5,86	3,15	3,38	3,61	3,83	4,06	4,28	4,51	4,73	4,96	5,18	5,41	5,63	5,86	5,86	5,86
3,50	6,55	3,51	3,74	3,98	4,21	4,44	4,68	4,91	5,14	5,38	5,61	5,85	6,08	6,31	6,55	6,55
3,75	7,26	3,87	4,12	4,36	4,60	4,84	5,08	5,33	5,57	5,81	6,05	6,29	6,54	6,78	7,02	7,26
4,00	8,00	4,25	4,50	4,75	5,00	5,25	5,50	5,75	6,00	6,25	6,50	6,75	7,00	7,25	7,50	7,75
4,25	8,76	4,64	4,90	5,15	5,41	5,67	5,93	6,18	6,44	6,70	6,96	7,22	7,47	7,73	7,99	8,25
4,50	9,55	5,04	5,30	5,57	5,83	6,10	6,36	6,63	6,89	7,16	7,42	7,69	7,95	8,22	8,49	8,75
4,75	10,35	5,45	5,72	5,99	6,27	6,54	6,81	7,08	7,36	7,63	7,90	8,17	8,45	8,72	8,99	9,26
5,00	11,18	5,87	6,15	6,43	6,71	6,99	7,27	7,55	7,83	8,11	8,39	8,66	8,94	9,22	9,50	9,78
5,25	12,03	6,30	6,59	6,87	7,16	7,45	7,73	8,02	8,31	8,59	8,88	9,17	9,45	9,74	10,02	10,31
5,50	12,90	6,74	7,04	7,33	7,62	7,92	8,21	8,50	8,79	9,09	9,38	9,67	9,97	10,26	10,55	10,85

a) The anchor spacing and the edge distance shall not be smaller than the minimum anchor spacing s_{min} and the minimum edge distance c_{min} .

Combined tension and shear loading

For combined tension and shear loading see section "Anchor Design".

